



**GLASS HINGED DOOR
&
INTERNAL SLIDING DOOR**

TABLE OF CONTENTS

INTERNAL SLIDING DOOR

DOOR SIZES RESTRICTION AND DETAIL	7
SLIDING DOOR FRAME AND TRACK	7
SLIDING DOOR DIVISION STYLE	8
INFRAME PANEL OPTION	9
INFRAME GLASS OPTION	9

GLASS HINGED DOOR

DOOR SIZES RESTRICTION AND DETAIL	13
HINGED DOOR FRAME DETAIL & GLASS OPTION	14
DOOR HINGE OPTION	15

BI-FOLD LIFT AND UP & OVER LIFT SYSTEM

AVENTOS HINGE SYSTEM DETAIL	19
-----------------------------	----

PREMIUM STACKING SLIDING DOOR

DOOR SIZES RESTRICTION AND DETAIL	23
PREMIUM DOOR FRAME	24
PREMIUM SLIDING DOOR TRACK OPTION	26
INFRAME GLASS OPTION	26

PREMIUM SIDE MOUNTED SLIDING DOOR

SIDE MOUNTED SLIDING DOOR SYSTEM: 1 DOORS	30
SIDE MOUNTED SLIDING DOOR SYSTEM: 2 DOORS	31

PREMIUM GLASS CAVITY SLIDING DOOR

GLASS CAVITY SLIDING DOOR SYSTEM: 1 DOORS	34
---	----

PLACE ORDER DETAIL

OPEN TRADE ACCOUNT	37
ORDER MANUFACTURING LEAD TIME	38
SHOWROOM AND FACTORY ADDRESS	39

INTERNAL SLIDING DOOR



FEATURES

- Ultra-quiet operation
- Custom sized sliding door, made to measure
- 4 TOP WHEELS + 2 BOTTOM WHEELS
- Infill panel 5MM Glass or Double-sided 9MM Melamine Panel
- Top and bottom track sliding door system
- Available in single, double and triple top and bottom track
- 2 Frame styles to choose from: Modern frame and Classic frame
- 3 Colour options for door frame: Silver, White & Black





DOOR SIZES RESTRICTION AND DETAIL

We understand the importance of finding the perfect door that not only enhances your space but also fits flawlessly within your home or office. We will provide you with essential information about our door size restrictions and requirements, ensuring a seamless installation process.

SLIDING DOOR SIZE RESTRICTION

Maximum and Minimum Dimensions:

Sliding door height

From 600MM Standard in height. To 2400MM Standard in height.

Sliding door width

From 600MM Standard in width. To 1200MM Standard in width.

(*Oversized width or height sliding door please email us separately.)

ULTRA QUIET SLIDING DOOR WHEEL

TOP: 1 Pair of wheels, Total 4 wheels.

BOTTOM: 1 Pair of wheels, Total 2 wheels.

Total 6 Wheels per sliding door.

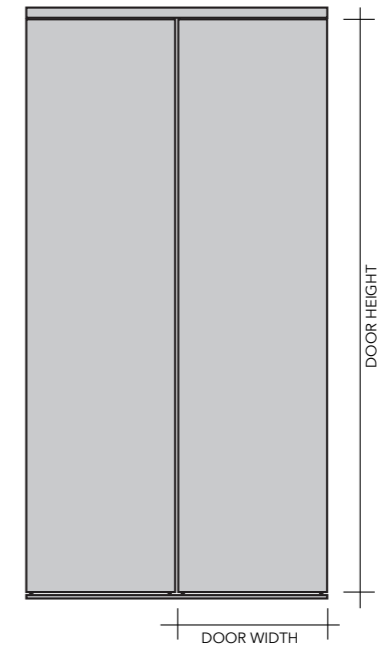
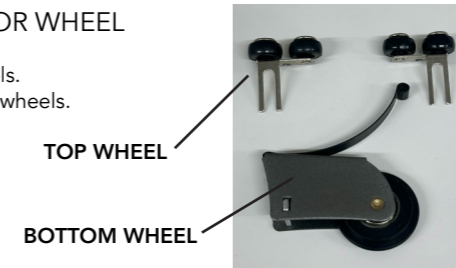

SLIDING DOOR FRAME OPTION

Two sliding door frame to choose, Modern frame and Classic frame in 3 standard colours.

MODERN FRAME

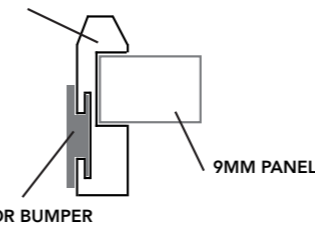

CLASSIC FRAME

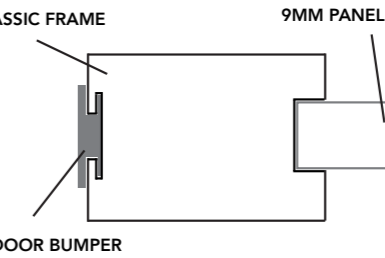

MODERN FRAME

Frame width: 11MM

Frame thickness: 33MM

Overlapping requirement: 15MM

Infill panel thickness: 9MM | Infill glass thickness: 5MM | Infill mirror thickness: 4MM

Standard frame colour: Anodised silver, Matt black, Matt white (*Custom colouring available at extra cost)

CLASSIC FRAME

Frame width: 50MM

Thickness: 35MM

Overlapping requirement: 50MM

SLIDING DOOR TRACK OPTION

2 or 4 sliding doors : Double track, door jamb require 90mm width, 3 sliding doors : Double/Triple track, door jamb require 90/130mm width. *FREE 9MM PACKER will be supplied on request for packing the bottom track to flush with the carpet height.

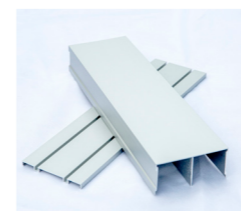

SILVER DOUBLE TRACK

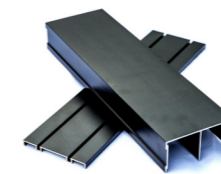

BLACK/WHITE DOUBLE TRACK

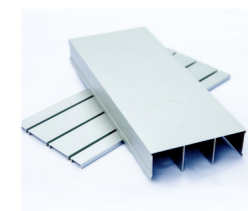

SILVER TRIPLE TRACK



BLACK/WHITE TRIPLE TRACK

SLIDING DOOR DIVISION STYLE

FULL PANEL

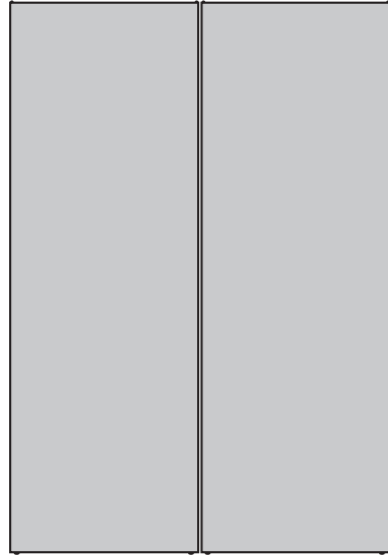

CENTER PANEL

CENTER PANEL STANDARD HEIGHT

160MM

CENTER PANEL OPTION:

SILVER MIRROR
GREY MIRROR
BRONZE MIRROR
CLEAR GLASS
GREY GLASS
BRONZE GLASS
ETCHED GLASS
OPAL LAMINATED GLASS
WHITE/COLOUR MELAMINE

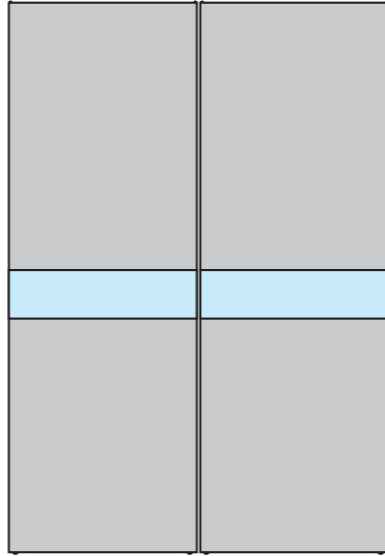

3 DIVISIONS

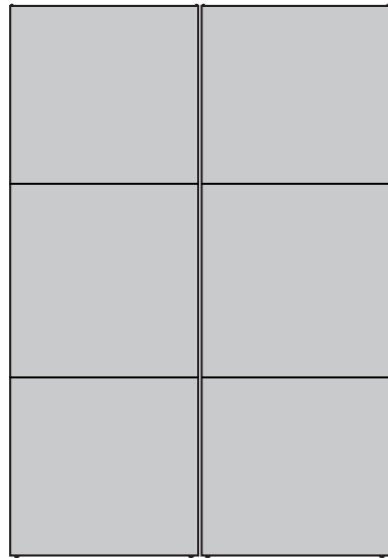

4 DIVISIONS

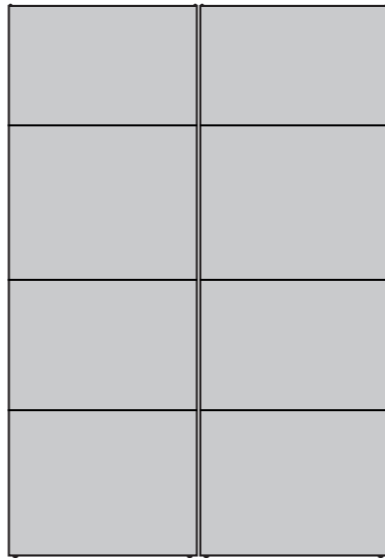

CENTER PANEL + 3 DIVISIONS

CENTER PANEL STANDARD HEIGHT

160MM

CENTER PANEL OPTION:

SILVER MIRROR
GREY MIRROR
BRONZE MIRROR
CLEAR GLASS
GREY GLASS
BRONZE GLASS
ETCHED GLASS
OPAL LAMINATED GLASS
WHITE/COLOUR MELAMINE

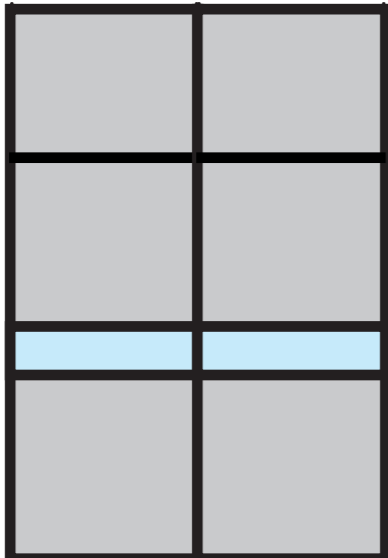

MIX PANEL

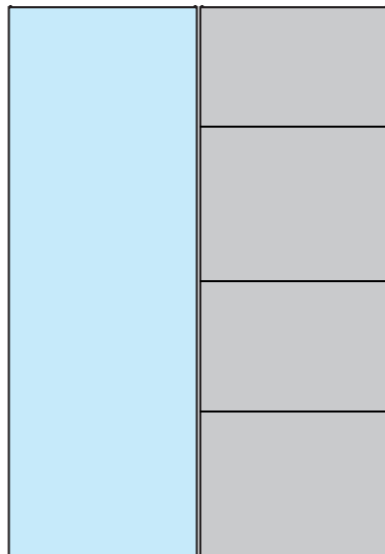

INFRAME PANEL OPTION

9MM Melamine panel

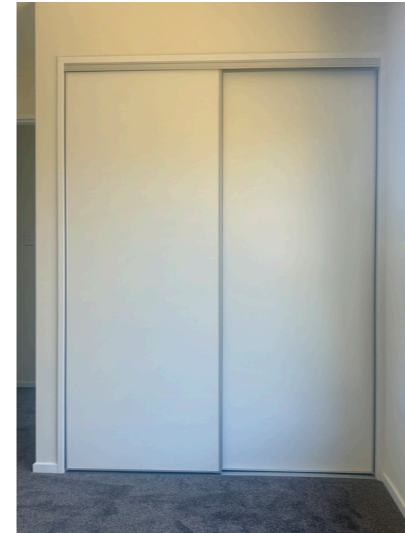

WHITE MELAMINE



COLOUR MELAMINE

OUR NEW ZEALAND COLOUR MELAMINE PANEL SUPPLIERS:

1. BESTWOOD
2. PRIME PANEL
3. MELTECA

Order lead time for colour melamine: 2-4 Weeks



Nova Interior Studio follows NZS 4223 and AS/NZS 2208 safety standards, using Grade A safety-rated glass (5mm thick) treated with toughening or backed with safety vinyl for mirrors.

INFRAME GLASS OPTION

5MM Toughened glass, mirror door with vinyl backing.

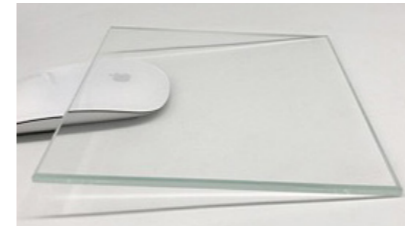

ULTRA-CLEAR TOUGHENED GLASS(LOW IRON)

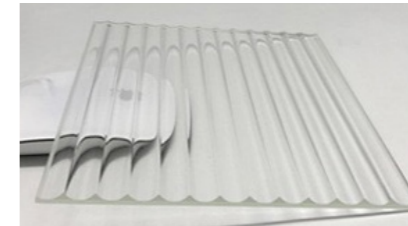

NARROW REEDED TOUGHENED GLASS



GREY TOUGHENED GLASS



COMPARING STD. CLEAR & LOW IRON GLASS



FROSTED ETCHED TOUGHENED GLASS



BRONZE TOUGHENED GLASS

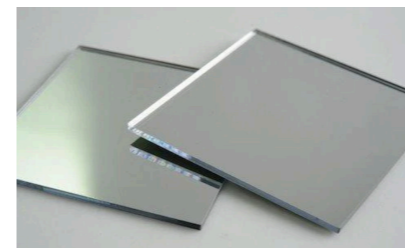

SILVER MIRROR GLASS

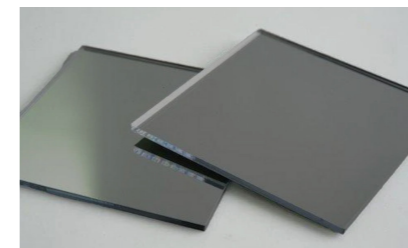

GREY MIRROR GLASS



BRONZE MIRROR GLASS



GLASS HINGED DOOR



FEATURES

- Ultra-quiet operation
- Custom sized glass hinged door, made to measure
- SOFT-CLOSE Mechanism
- Infill panel 5MM Toughened Glass
- Option for with handle or without handle
- Up to 4 hinge options for door opening mechanism



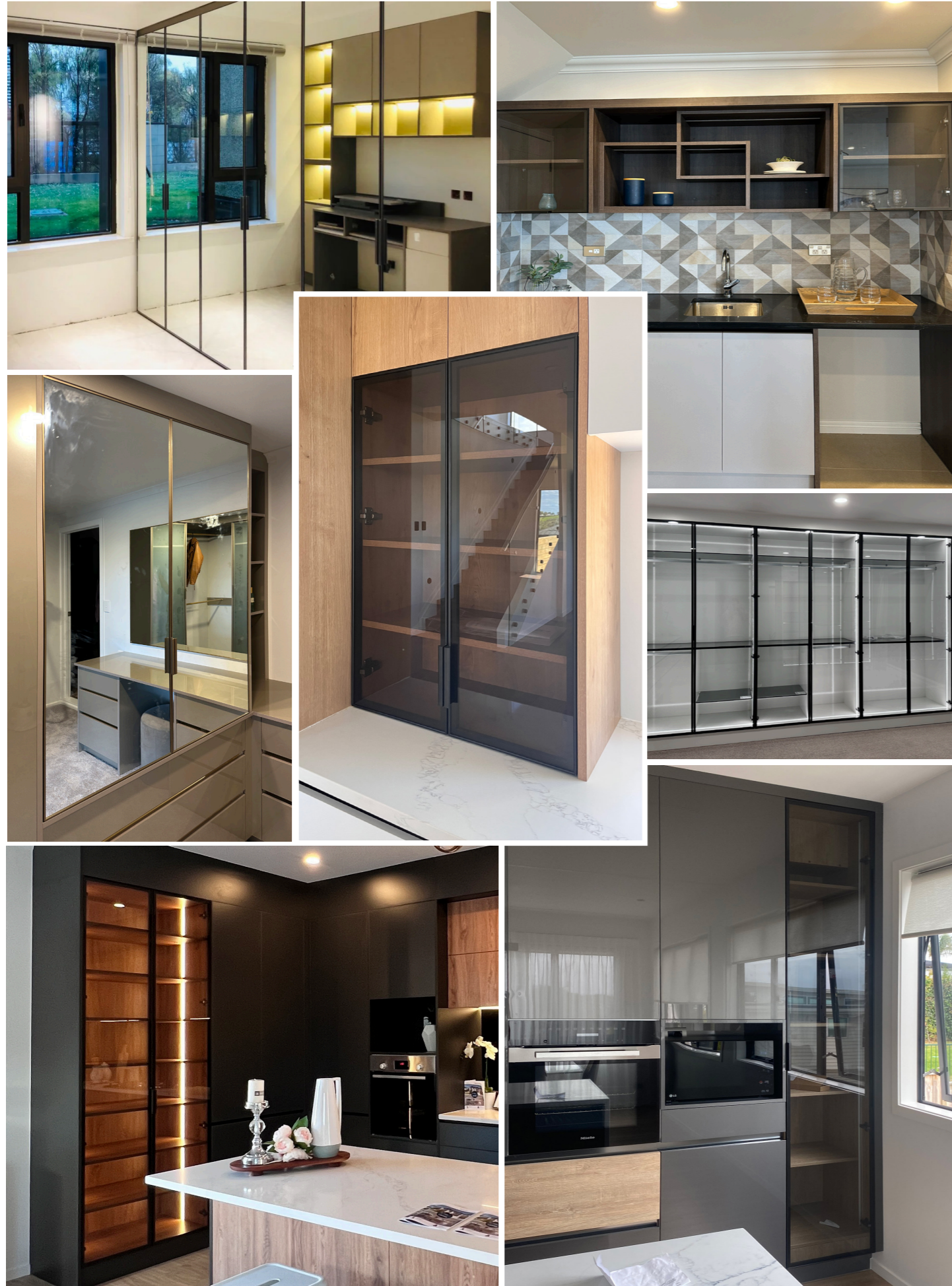

DOOR SIZES RESTRICTION AND DETAIL

We understand that each space is unique, and our team is dedicated to providing you with the perfect door solution tailored to your requirements. In this section, we will explore the door size restrictions and requirements for our glass hinged doors, ensuring a seamless integration into your space.

Door Size Restrictions

At Nova Interior, we offer custom-made glass hinged doors, meaning we can create doors to fit a wide range of dimensions. However, it is important to consider certain restrictions when it comes to door sizes. Here are a few key points to keep in mind:

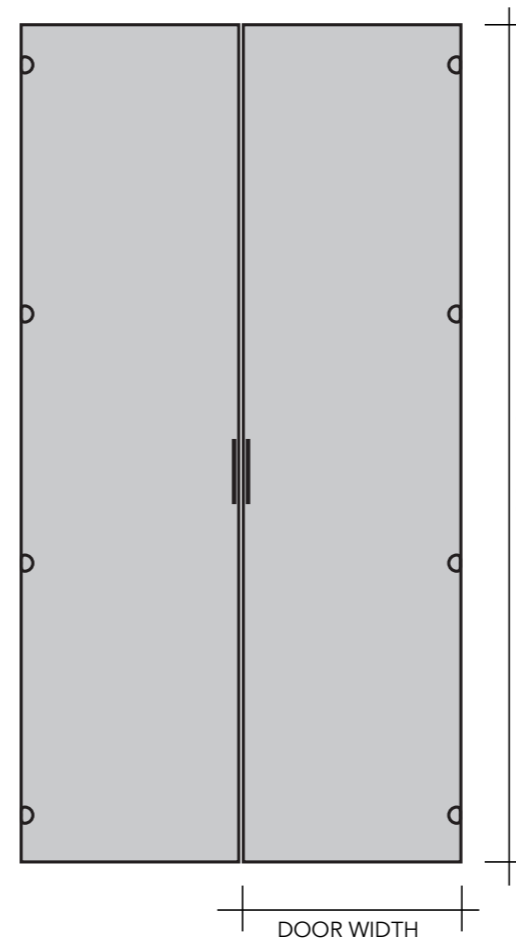

Door frame dimensions

Front frame width: 5MM
Frame thickness: 21MM

Required cabinet depth: 24MM
Frame width: 20MM
Infill glass thickness: 5MM
Standard frame colour: Matt black
(*Custom colouring available at extra cost)

Maximum and Minimum Dimensions:

Hinged door height
From 600MM Standard in height
To 2400MM Standard in height

Hinged door width
From 300MM Standard in width
To 600MM Standard in width.

*Oversized width or height glass hinged door please email us separately.

Hinge requirement:

1701mm ~ 2400mm height : 5 hinges
901mm ~ 1700mm height : 4 hinges
Below 900mm height : 2-3 hinges

*Handle center height lowest and highest : 135mm
*Hinge center height lowest and highest : 90mm

Soft-close hinge option:

1. STANDARD FULL OVERLAY (OPEN UP TO 90 DEGREE)
2. HALF OVERLAY (OPEN UP TO 90 DEGREE)
3. FULL OVERLAY 165 DEGREE (OPEN UP TO 165 DEGREE)
4. FULL INSET (OPEN UP TO 90 DEGREE)

ULTRA-CLEAR TOUGHENED
GLASS HINGED DOOR



GLASS HINGED DOOR FRAME



DOOR FRONT SIDE



DOOR FRONT SIDE



DOOR BACK SIDE WITH SCREWS



HANDLE FRONT SIDE

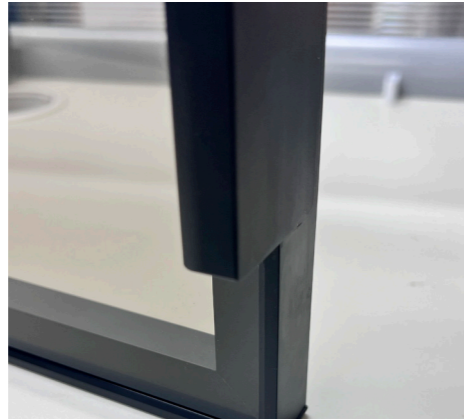

HANDLE FRONT SIDE DETAIL



HANDLE BACK SIDE WITH SCREWS

INFRAME GLASS OPTION

5MM Toughened glass, mirror door with vinyl backing.

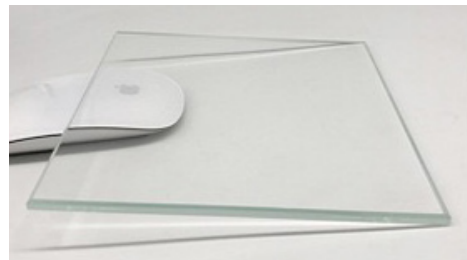

ULTRA-CLEAR TOUGHENED GLASS(LOW IRON)



NARROW REEDED TOUGHENED GLASS



GREY TOUGHENED GLASS



COMPARING STD. CLEAR & LOW IRON GLASS



FROSTED ETCHED TOUGHENED GLASS



BRONZE TOUGHENED GLASS

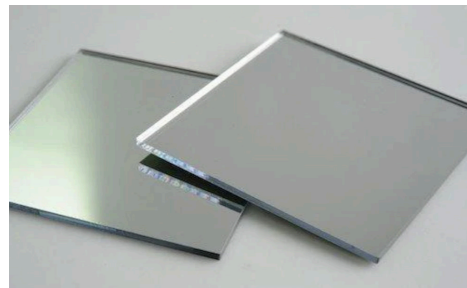

SILVER MIRROR GLASS

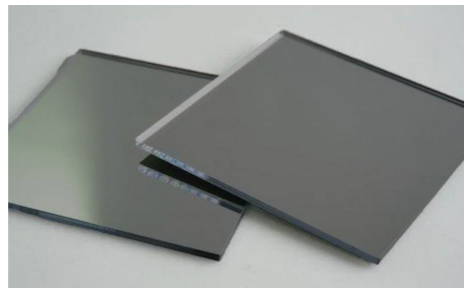

GREY MIRROR GLASS



BRONZE MIRROR GLASS

NOVA STANDARD HINGES OPTION



Standard concealed hinge with integrated Silent System

Standard mounting plate for screwing on for aluminium framed door 95° opening angle



Hole line distance LR 35mm

Hole spacing 32mm

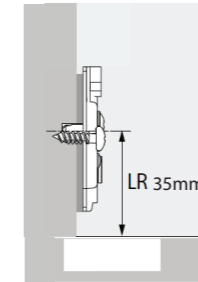

For 3.5mm Ø x 16mm Countersink screws
Pre Drill: Diameter : 3mm | Depth 0.5mm
Hole Line Distance LR : 35mm
Hole Spacing : 32mm

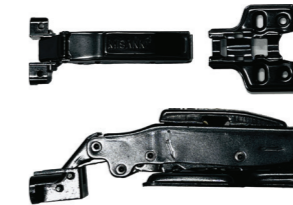

Concealed hinge with clip on installation and integrated Silent System
For 20 mm wide aluminium framed profiles
Integrated overlay adjustment + 2 mm / - 2 mm
Integrated depth adjustment + 3 mm / - 2 mm
All visible parts in obsidian black
Hinge arm material: steel in obsidian black
Hinge cup material: zinc die-cast in obsidian black
Including 4 fixing screws

OPTION 1: Full overlay hinge

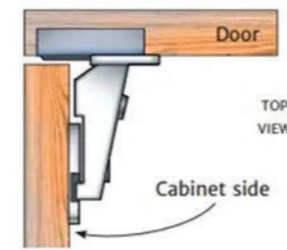

OPTION 2: Half overlay hinge

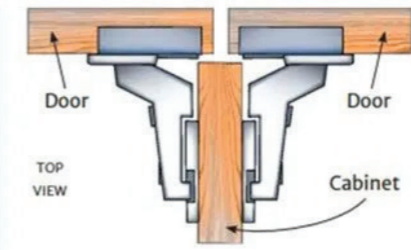

OPTION 3: INSET hinge

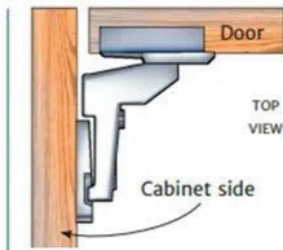

OPTION 4: 165° opening angle hinge

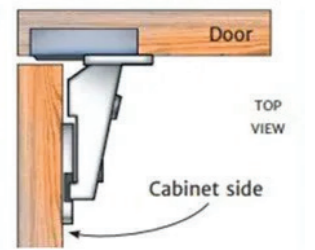

PREMIUM HETTICH HINGES OPTION



Fast assembly concealed hinge with integrated Silent System

Sensys 8638i in obsidian black, for aluminium framed door 95° opening angle



FULL OVERLAY 95°

Hole line distance LR 20mm

Hole spacing 32mm

Concealed hinge with clip on installation and integrated Silent System
Quality classification under EN 15570, Level 3
For 20 mm wide aluminium framed profiles
Integrated overlay adjustment + 2 mm / - 2 mm
Integrated depth adjustment + 3 mm / - 2 mm
Height adjustment at mounting plate
All visible parts in obsidian black
Hinge arm material: steel in obsidian black
Hinge cup material: zinc die-cast in obsidian black
Including 2 fixing screws

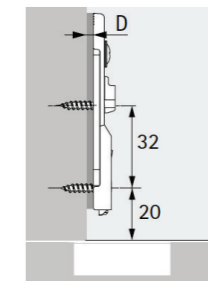
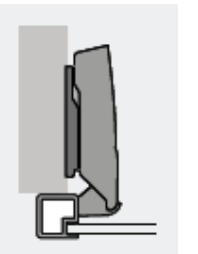

For 3.5 mm Ø x 16 mm countersunk screws
Quality classification under EN 15570, Level 3
Eccentric cam height adjustment ± 2 mm
Steel in obsidian black

BI-FOLD LIFT SYSTEM AND UP & OVER LIFT SYSTEM



FEATURES

- Ultra-quiet operation
- Custom sized bi-fold lift hinged door, made to measure
- SOFT-CLOSE Mechanism
- Infill panel 5MM Toughened Glass
- Option for with handle or without handle
- BLUM hinge hardware



Bi-fold lift system and Up & over lift system for Glass hinged door



AVENTOS

AVENTOS lift systems were created to make moving through the kitchen seamless, providing unlimited functionality with a modern style. With AVENTOS, you can retrieve items from your cabinets quickly and easily – moving up and out of the way and staying put where you leave them. With the option of adding SERVO-DRIVE, the electrical touch-to-open system, you can simply touch the front and it opens instantly.

AVENTOS

HF



Bi-fold Lift System

The two-part front folds together in the center when opening. This lift system is ideal for taller wall cabinets with large fronts.

Height range:

479 to 1067

Width range:

381 to 1200

Closes silently and effortlessly with BLUMOTION

AVENTOS

HS



Up & Over Lift System

The front swings over the cabinet and is ideal for large-area, single fronts. The up-and-over lift system is also perfect for cabinets with crown molding.

Height range:

350 to 800

Width range:

381 to 1200

Closes silently and effortlessly with BLUMOTION



PREMIUM STACKING SLIDING DOOR

FEATURES

- Ultra-quiet operation
- Custom sized sliding door, made to measure
- SOFT-CLOSE Mechanism
- Infill panel 6MM Glass or Double-sided acrylic panel
- Top hung sliding door system, no bottom tracks
- Up to 4 sliding doors for stacking door mechanism

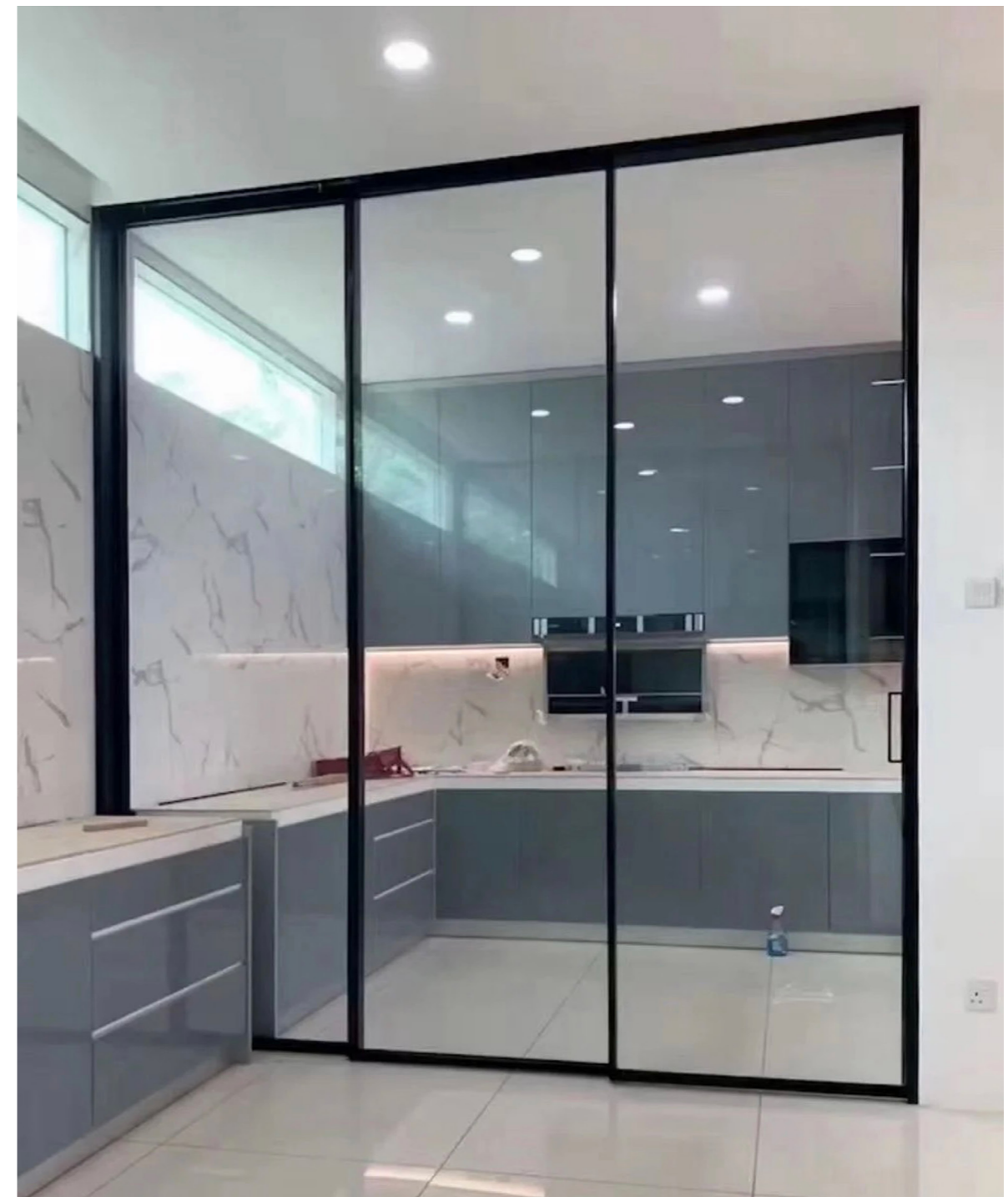



DOOR SIZES RESTRICTION AND DETAIL

Enhance the beauty and functionality of your living space with our Premium Stacking Sliding Door with Soft-Closing. This innovative and stylish door offers a seamless transition between your indoor areas while providing unrivaled convenience and durability.

SLIDING DOOR SIZE RESTRICTION

Maximum and Minimum Dimensions:

Sliding door height
From 600MM Standard in height. To 2400MM Standard in height.

Sliding door width
From 600MM Standard in width. To 1200MM Standard in width.
(*Oversized width or height sliding door please email us separately.)

ULTRA QUIET SLIDING DOOR SET

Smooth and Effortless Operation: The sliding mechanism of our Premium Stacking Sliding Door ensures a smooth and effortless operation, allowing you to easily open and close the door with minimal effort.

Space-saving Stacking Design: With its unique stacking feature, this sliding door saves valuable floor space. When fully opened, the door panels neatly stack to the side, creating an unobstructed opening and maximizing the flow of natural light and fresh air into areas.

Soft-Close Technology: Our Premium Stacking Sliding Door is equipped with innovative Soft-Closes technology, ensuring gentle and controlled closing. This feature eliminates any slamming noises and prevents sudden impacts, providing a quieter and safer environment for you and your loved ones.

Exceptional Durability: Crafted from high-quality materials, including robust frames and premium glass, this sliding door is built to withstand the test of time. Its durable construction ensures long-lasting performance, making it a reliable and sustainable investment for your home.

Customisation Options: We understand that every home is unique, which is why we offer a range of customization options for our Premium Stacking Sliding Door. Choose from various frame colours, glass options, and sizes to create a door that perfectly complements your home's architectural style and personal preferences.

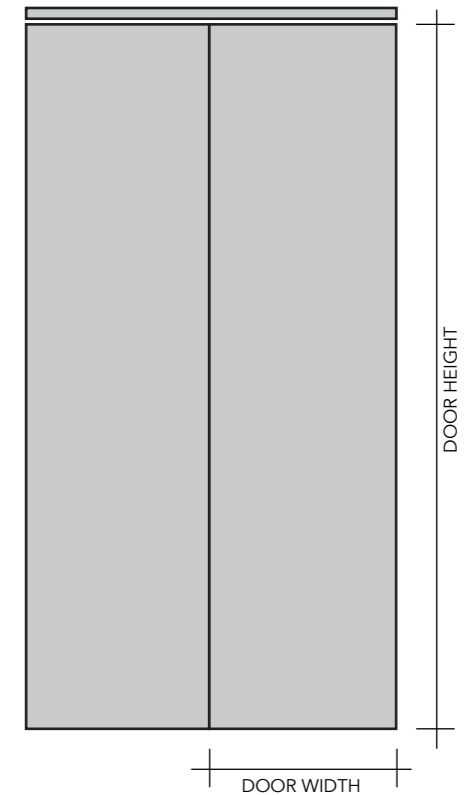

PREMIUM STACKING SLIDING DOOR FRAME OPTION

Front frame width: 16MM
Frame thickness: 45MM
Handle height: 150MM
Handle width: 46MM

Overlapping requirement: 15MM
Infill glass thickness: 6MM
Infill mirror thickness: 6MM
Standard frame colour: Matt black
(*Custom colouring available at extra cost)

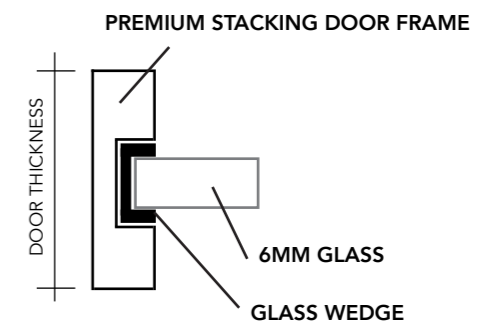

SLIDING DOOR TRACK OPTION

Top hung track with soft-close open & close, no bottom track required. (Drawing on page 22 ~ page 23.)

- A. TOP HUNG SOFT-CLOSE SLIDING DOOR SYSTEM: 2 DOORS
- B. TOP HUNG STACKING + SOFT-CLOSE SLIDING DOOR SYSTEM 2 SLIDING DOOR + 0 FIXING DOOR: 2 DOORS
- C. TOP HUNG STACKING + SOFT-CLOSE SLIDING DOOR SYSTEM 2 SLIDING DOOR + 1 FIXING DOOR: 3 DOORS
- D. TOP HUNG STACKING + SOFT-CLOSE SLIDING DOOR SYSTEM 3 SLIDING DOOR + 0 FIXING DOOR: 3 DOORS
- E. TOP HUNG STACKING + SOFT-CLOSE SLIDING DOOR SYSTEM 3 SLIDING DOOR + 1 FIXING DOOR: 4 DOORS
- F. TOP HUNG STACKING + SOFT-CLOSE SLIDING DOOR SYSTEM 2 SLIDING DOOR + 2 FIXING DOOR: 4 DOORS



PREMIUM SLIDING DOOR FRAME



PREMIUM SLIDING DOOR FRAME DETAIL

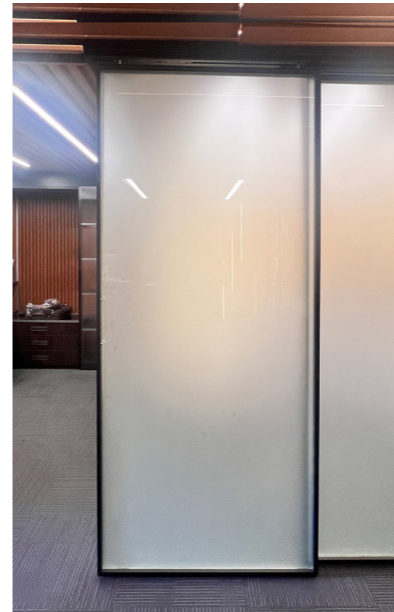

SLIDING DOOR FRONT



STACKED SLIDING DOOR



STACKED SLIDING DOOR



SLIDING DOOR BOTTOM



DOOR HANDLE



DOOR HANDLE TOP VIEW



Nova Interior Studio follows NZS 4223 and AS/NZS 2208 safety standards, using Grade A safety-rated glass (6mm thick) treated with toughening or backed with safety vinyl for mirrors.

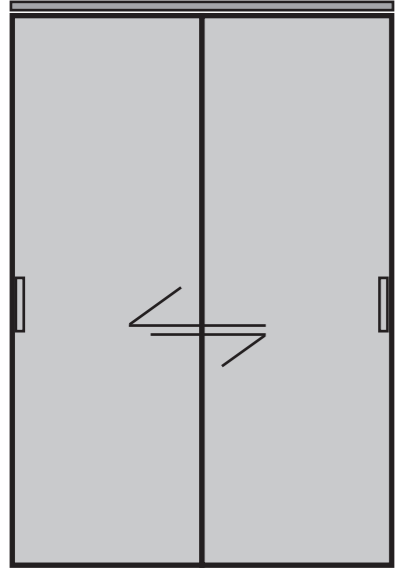

PREMIUM SLIDING DOOR TRACK OPTION

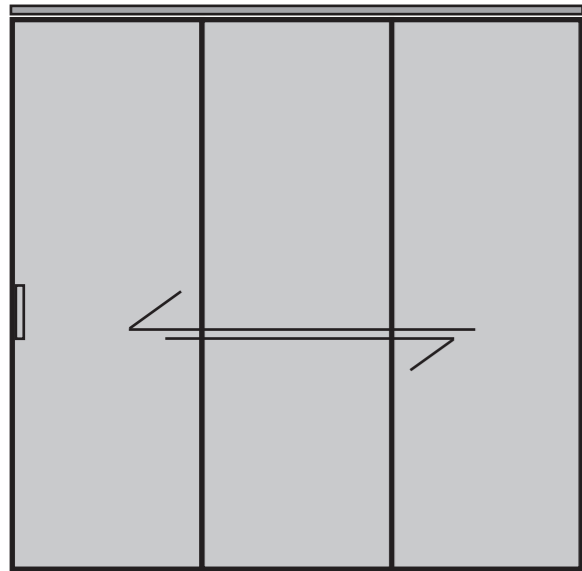
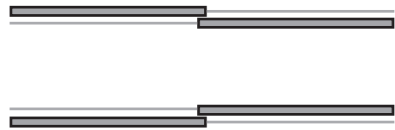

**PREMIUM SOFT-CLOSE
TOP HUNG 2 SLIDING DOOR SYSTEM**



**PREMIUM STACKING SOFT-CLOSE
TOP HUNG SLIDING DOOR 3 SLIDING DOOR
+ 1 FIXING DOOR SYSTEM**

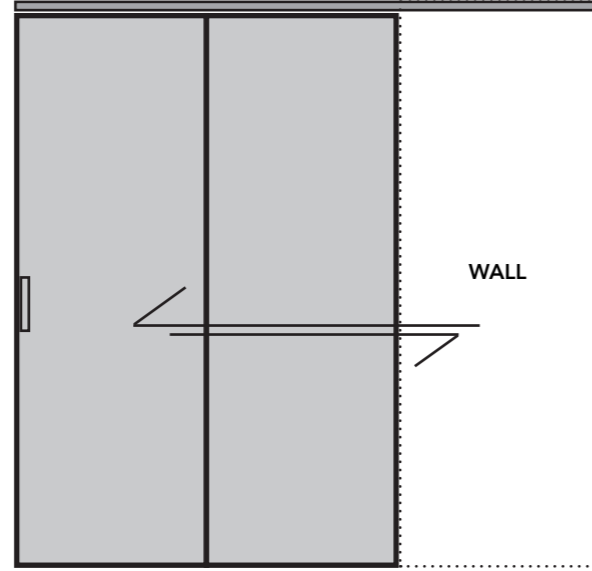

**PREMIUM STACKING SOFT-CLOSE
TOP HUNG SLIDING DOOR 2 SLIDING DOOR + 0 FIXING DOOR SYSTEM**

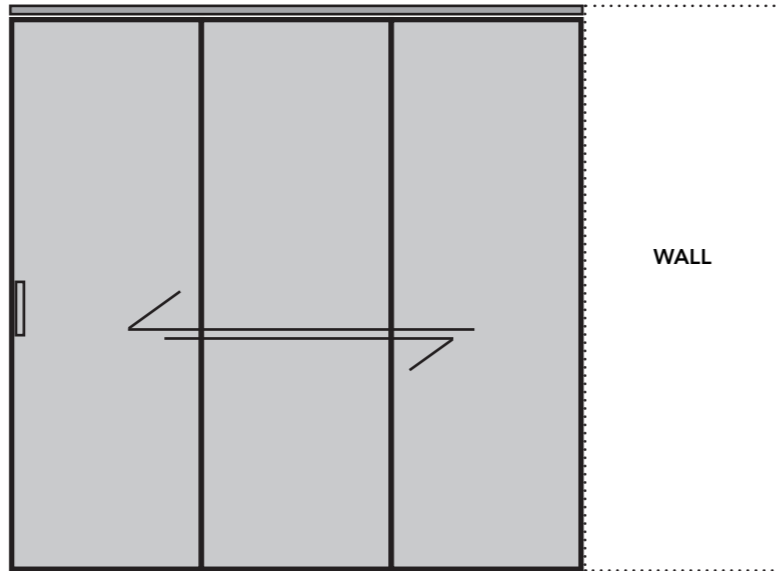
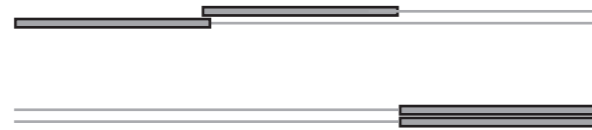

**PREMIUM STACKING SOFT-CLOSE
TOP HUNG SLIDING DOOR 3 SLIDING DOOR + 0 FIXING DOOR SYSTEM**

Sliding doors can be opened from left or right side.

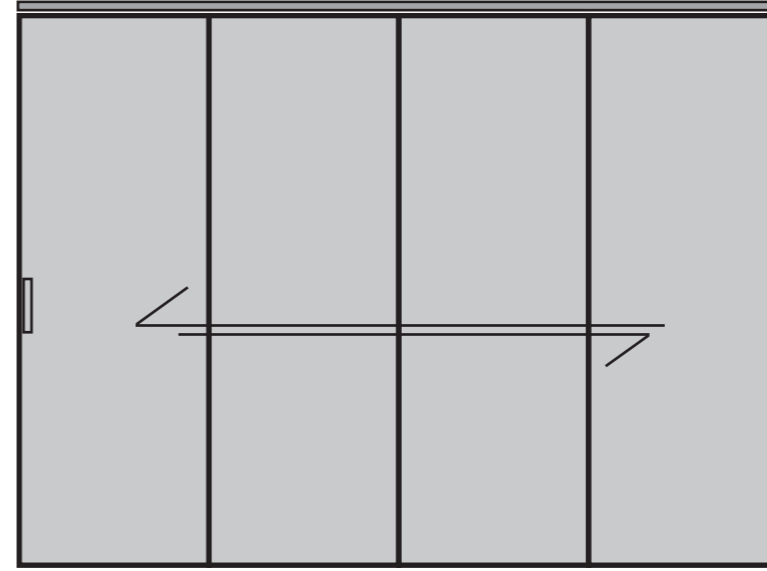
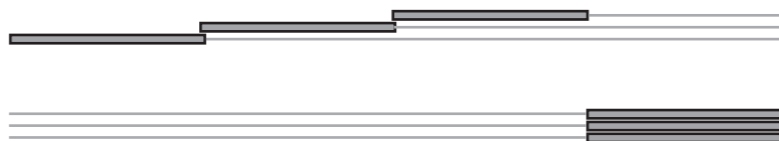

**PREMIUM STACKING SOFT-CLOSE
TOP HUNG SLIDING DOOR 3 SLIDING DOOR + 1 FIXING DOOR SYSTEM**

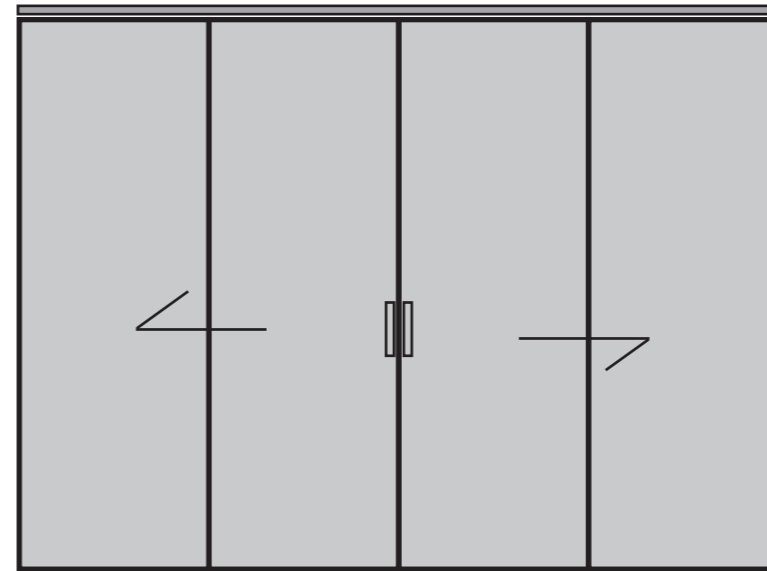
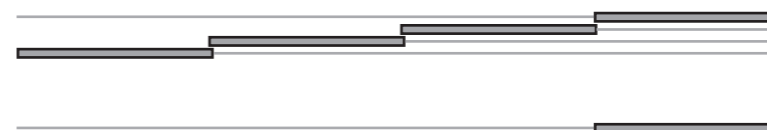

**PREMIUM SOFT-CLOSE
TOP HUNG SLIDING DOOR 2 SLIDING DOOR + 2 FIXING DOOR SYSTEM**

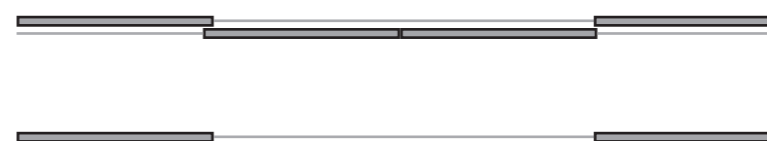

GLASS OPTION

6MM Toughened glass for stacking door.



ULTRA-CLEAR TOUGHENED GLASS (LOW IRON)



NARROW REEDED TOUGHENED GLASS



FROSTED ETCHED TOUGHENED GLASS



GREY TOUGHENED GLASS



BRONZE TOUGHENED GLASS



PREMIUM SIDE MOUNTED SLIDING DOOR

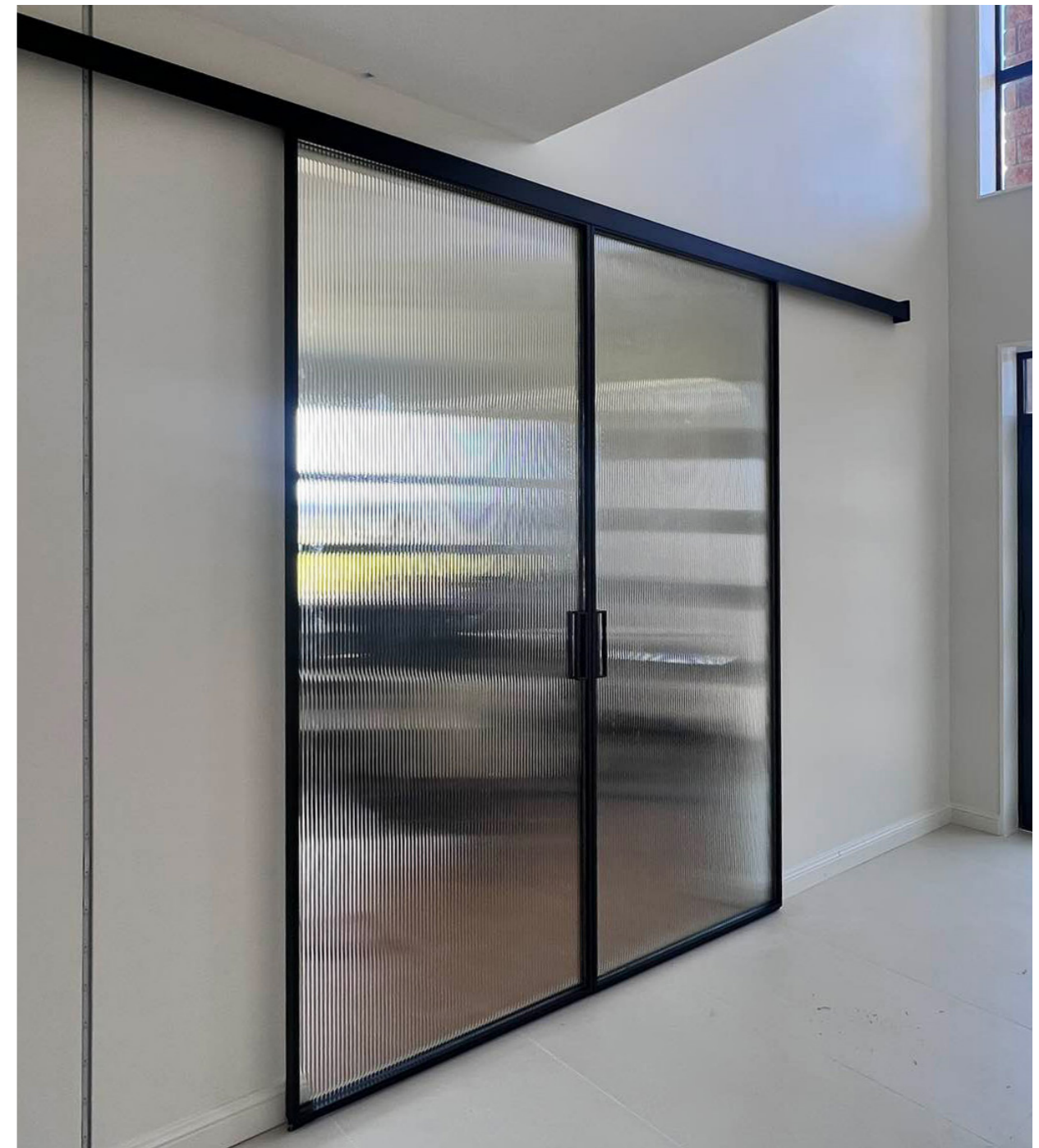

FEATURES

- Ultra-quiet operation
- Custom sized sliding door, made to measure
- SOFT-CLOSE Mechanism
- Infill panel 6MM Glass or Double-sided acrylic panel
- Side mounted sliding door system, no bottom tracks
- Up to 2 sliding doors for side mounted sliding door



SIDE MOUNTED SLIDING DOOR SYSTEM: 1 SLIDING DOOR

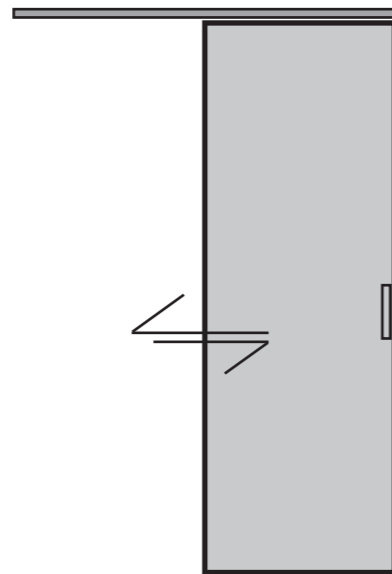

**PREMIUM SOFT-CLOSE SIDE MOUNTED SLIDING DOOR SYSTEM:
1 Sliding door**



SIDE MOUNTED SLIDING DOOR SYSTEM: 2 SLIDING DOORS

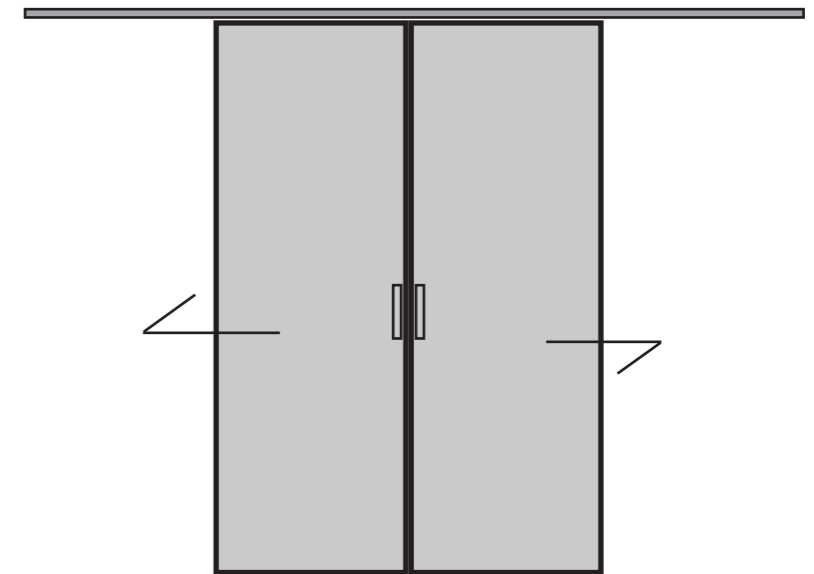
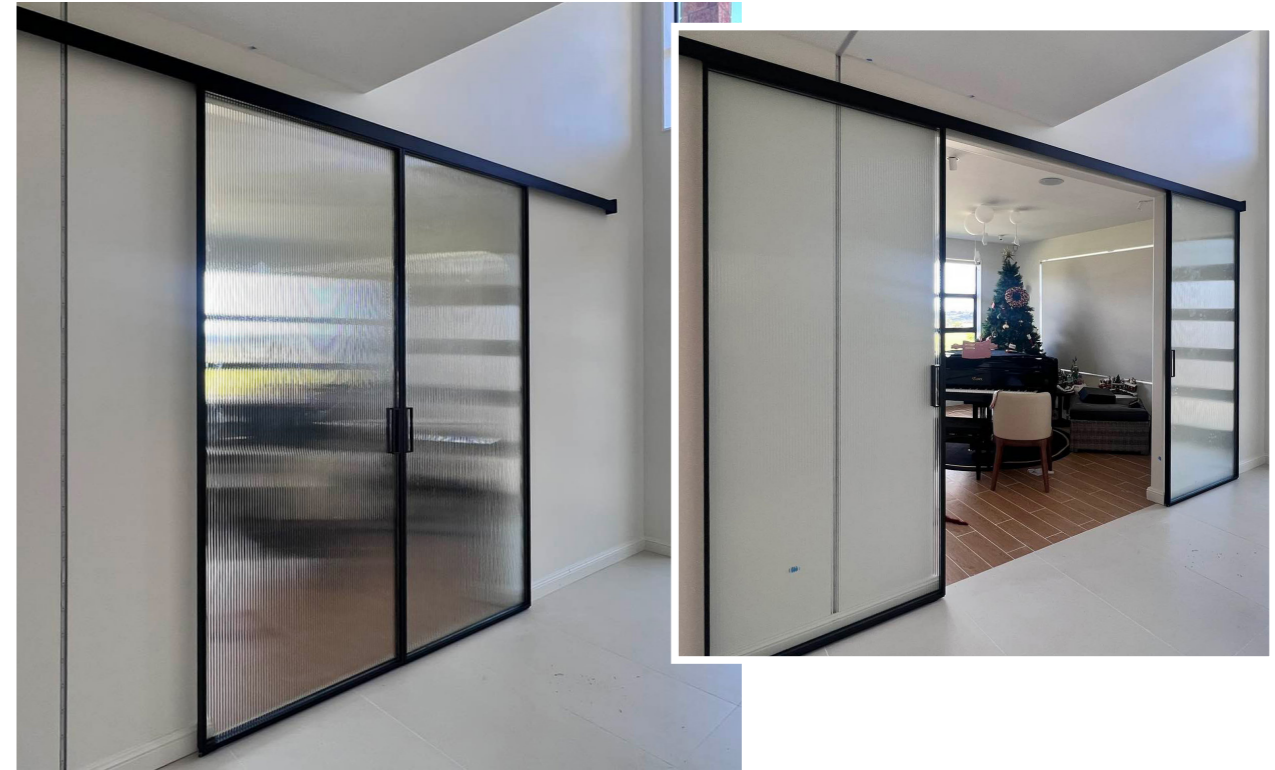

**PREMIUM SOFT-CLOSE SIDE MOUNTED SLIDING DOOR SYSTEM:
2 Sliding doors**



PREMIUM GLASS CAVITY SLIDING DOOR

FEATURES

- Ultra-quiet operation
- Custom sized cavity sliding door with pocket frame, made to measure
- SOFT-CLOSE Mechanism
- Infill panel 6MM Glass or Double-sided acrylic panel
- Glass cavity sliding door system, no bottom tracks
- Included glass sliding door, cavity pocket and wheel sets in order

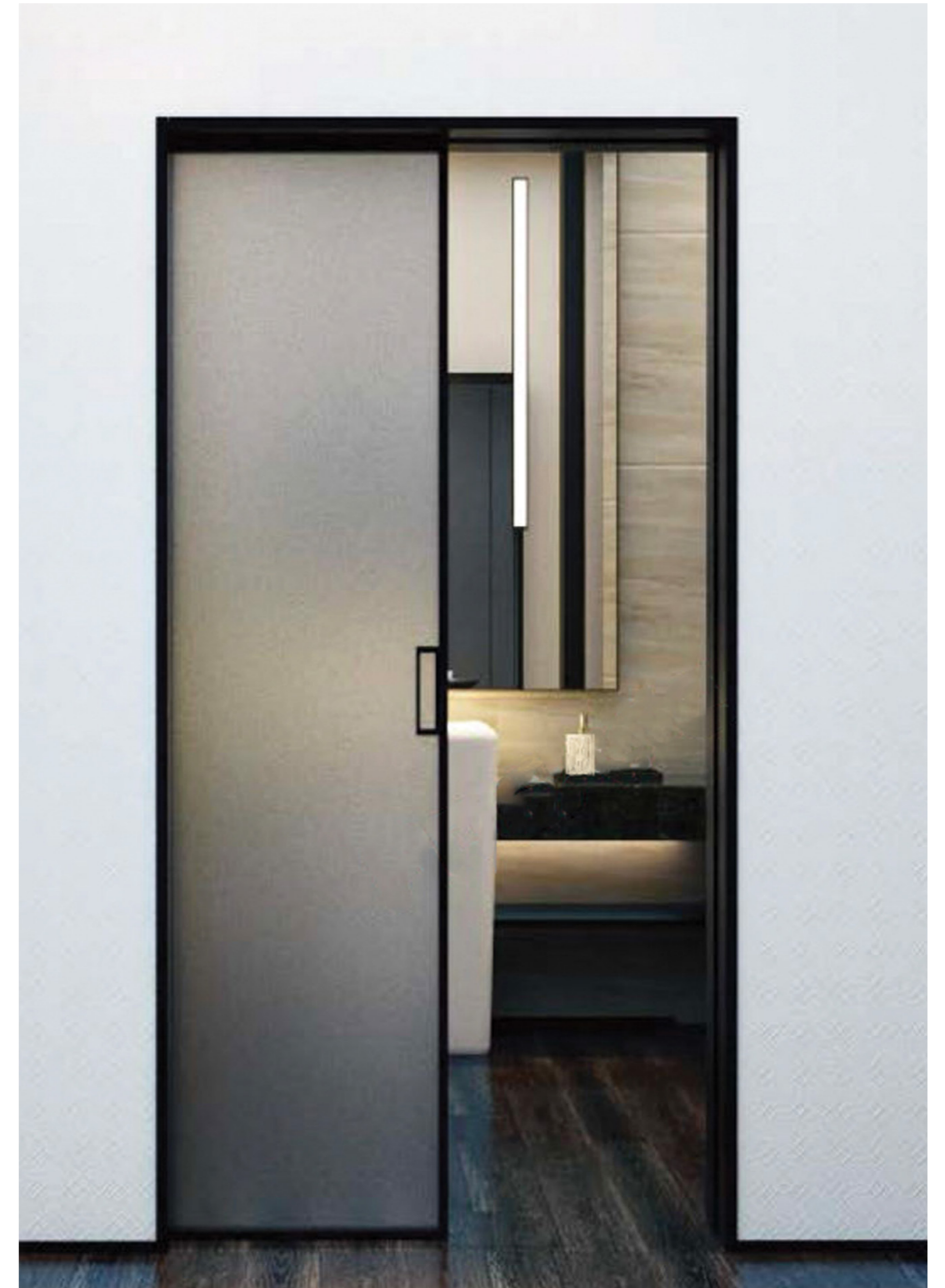

PREMIUM GLASS CAVITY SLIDING DOOR SYSTEM: 1 SLIDING DOOR



GLASS CAVITY SLIDING DOOR
FULLY CLOSED



GLASS CAVITY SLIDING DOOR
HALF OPENED

OUR PREMIUM SOFT-CLOSE GLASS POCKET DOOR

Designed with precision, our doors feature a matte black aluminum frame that adds a touch of timeless luxury to any space. The frame's durability ensures long-lasting performance, while its sleek profile enhances the overall aesthetic appeal.

The 6mm glass panels not only provide transparency but also allow abundant natural light to flow into your home. Experience the beauty of open and inviting spaces, creating an ambiance that is both refreshing and welcoming.

Operation is a breeze with handles conveniently placed on both sides of the doors. Effortlessly move in and out of rooms, enjoying the smooth functionality that our system provides.



GLASS CAVITY SLIDING DOOR
FULLY OPENED

Embrace the future of architectural design with our glass cavity sliding door system. Discover a perfect balance of form and function, where sophistication meets convenience.



PLACE ORDER DETAIL

OPEN TRADE ACCOUNT @ NOVAINTERIOR

We're thrilled to have you join our family of valued clients. As a premier destination for interior design and solutions, we are committed to providing you with an exceptional experience and helping you bring your vision to life.

At NOVA INTERIOR STUDIO LIMITED, we understand that your space is a reflection of your unique style and personality. Our team of skilled professionals is dedicated to crafting bespoke designs tailored to your specific needs and preferences.

As you open your account with us, you gain access to a world of possibilities. Our extensive range of services, curated products, and innovative solutions ensures that we can cater to your every requirement. Whether you're seeking a home renovation, a new office design, or simply looking to add a touch of sophistication to your living spaces, we've got you covered.

Rest assured that our commitment to excellence extends beyond design. We prioritize superior customer service, transparent communication, and timely project delivery. Your satisfaction is our top priority, and we go above and beyond to exceed your expectations.

We invite you to explore the endless possibilities that lie ahead. Let us embark on this exciting journey together, transforming your spaces into stunning works of art. Get ready to experience a world of creativity, innovation, and personalized solutions like never before.

Thank you for choosing NOVA INTERIOR STUDIO LIMITED. We can't wait to collaborate with you and create spaces that truly inspire.

NEW ACCOUNT SUBMISSION EMAIL ADDRESS:

accounts@novainterior.co.nz

TRADE ACCOUNT PACKAGE:

1. Access our pricing system for your quotation or orders.
2. Access our project photo library to showcase your valuable customers.
3. FREE SAMPLE KIT SET for our products
4. Account manager to help you keep tracking your orders.
5. Installation guides for our products
6. Building material product training
7. Showroom/workshop renovation support
8. Quick turnaround



ORDER MANUFACTURING LEAD TIME

Welcome to the world of NOVA INTERIOR STUDIO LIMITED, where we redefine elegance and efficiency in door manufacturing. We understand the urgency and excitement that comes with transforming your space, and we take pride in our industry-leading lead times. Our streamlined processes allow us to deliver your dream doors quickly, without compromising on quality or style.

Top and Bottom Track Sliding Door: Ready in Just 2 Weeks!

Experience the seamless glide of our top and bottom track sliding doors, crafted to enhance any room effortlessly. From luxurious homes to contemporary offices, these sleek doors combine aesthetics with top-notch performance. And the best part? Our streamlined production ensures that your top and bottom track sliding door will be installed in a mere 2 weeks, leaving your space waiting no longer.

Glass Hinged Door: Unveiling in Just 2 Weeks!

Elevate your entrance with our stunning glass hinged doors, embodying sophistication and grace. These doors invite natural light while ensuring privacy, creating an open and welcoming atmosphere. The wait? Just 2 weeks, and you'll be welcoming guests through your beautiful glass hinged door in no time.

Stacking Sliding Door: Slide into Luxury in Just 2 Weeks!

Embrace the epitome of versatility and space-saving design with our remarkable stacking sliding doors. Whether you're connecting indoor and outdoor spaces or creating flexible room divisions, these doors offer a stylish solution. Rest assured, your stacking sliding door will be expertly crafted and delivered within 2 weeks, effortlessly transforming your space.

Glass Cavity Sliding Door: Unveiling Brilliance in 3-4 Weeks!

For those seeking elegance combined with superior functionality, our glass cavity sliding doors are a testament to refined craftsmanship. These doors seamlessly disappear into the wall cavity, optimizing space and enhancing the visual appeal of any room. Although these extraordinary doors require a bit more time to perfect, you'll be rewarded with a masterpiece in just 3-4 weeks.

Custom Color Melamine Sliding Door: Personalized Luxury in 2-4 Weeks!

Unleash your creativity with our custom color melamine sliding doors, where style meets customization. Let your imagination run wild as you choose from a wide range of vibrant colors, patterns, and textures to perfectly complement your space. While the manufacturing process for these bespoke doors takes a bit longer, our team will ensure your vision comes to life within 2-4 weeks.

OFFICE AND FACTORY ADDRESS



COMPANY NAME:

NOVA INTERIOR STUDIO LIMITED

SHOWROOM & FACTORY ADDRESS:

UNIT B / 349 East Tamaki Rd, East Tamaki,
Auckland,
NEW ZEALAND

SHOWROOM & OFFICE CONTACT:
+649 527 1602

SALES TEAM EMAIL:
sales@novainterior.co.nz

ACCOUNT TEAM EMAIL:
accounts@novainterior.co.nz

OFFICE HOURS:

MONDAY - FRIDAY 08:30 - 4:30
CLOSED ON PUBLIC HOLIDAYS



WEBSITE QR CODE LINK

www.novainterior.co.nz



